

AIWA®

LX-330

STEREO TURNTABLE SYSTEM

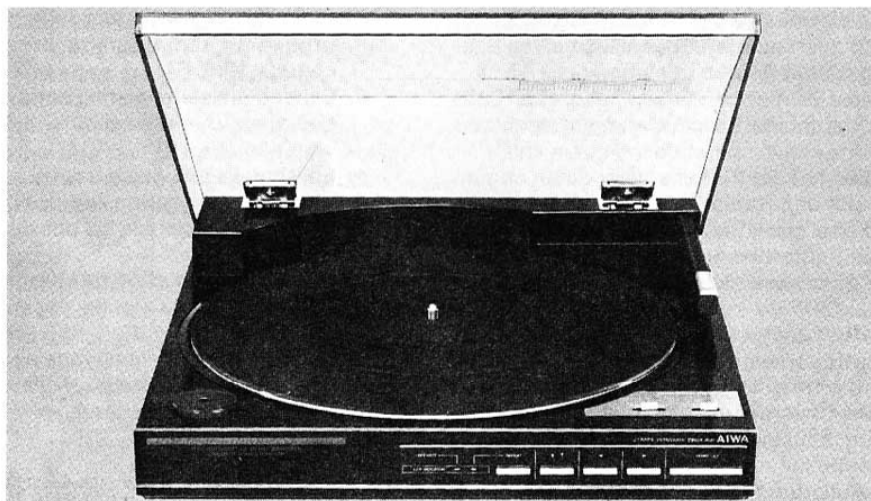

OWNER'S RECORD

For your convenience, record the model number and serial number (you will find them on the rear of your set) in the space provided below. Please refer to them when you contact your AIWA dealer in case of difficulty. This will be a great help to you in getting better and more satisfactory service on your set.

Model No.

LX-330

Serial No.

ATTESTATION

La société AIWA Co., Ltd. atteste que le Platine tourne-disque Modèle LX-330 est conforme aux dispositions de l'arrêté du 14 janvier 1980 relatif à la réglementation de l'importation, de la mise en vente et de la vente des appareils électrodomestiques, outils portatifs et appareils similaires, susceptibles de perturber la réception des émissions radioélectriques.

WARNING:

TO PREVENT FIRE OR ELECTRICAL SHOCK HAZARD, DO NOT EXPOSE THIS APPLIANCE TO RAIN OR MOISTURE.

Please use the LX-330 in combination with the AIWA Series 4000 or Series 3000 stereo systems.

CAUTIONS FOR OPERATION

Bear in mind the following points. Heeding these recommendation will allow this turntable to display its performance to the full.

1. For optimum performance the turntable must be completely level. Make absolutely sure that it is on the horizontal. **[Fig. 1]**
 2. Use a soft brush to remove dust from the stylus tip. Do not touch the stylus or apply any pressure to it. **[Fig. 2]**
 3. In order to prevent acoustic feedback, install the turntable as far away from the speakers as possible. Avoid installing it on top of the speakers. **[Fig. 3]**
 4. Do not force the tone arm. **[Fig. 4]**
 5. Avoid installing or operating the turntable in locations which are in the sun, near stoves or other places which are extremely hot. **[Fig. 5]**
 6. Avoid using the turntable in places subject to high levels of humidity, dust or vibration. **[Fig. 6]**
- In some cases, placing this turntable in close proximity to an FM tuner or radio will have adverse effect on the radio reception. If this occurs, position the units further apart.

Cleaning the turntable

- When the turntable needs cleaning, wipe off dirt with a piece of gauze or soft cloth dipped in a solution of diluted neutral detergent.
- Use a damp cloth to clean the dust cover in order to prevent static from being generated.

[Fig. 1], [Abb. 1], [圖 1]

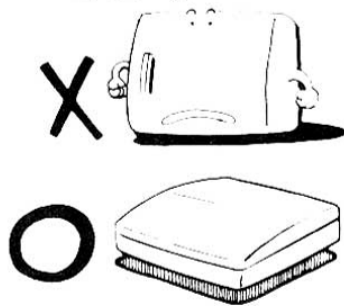

[Fig. 2], [Abb. 2], [圖 2]

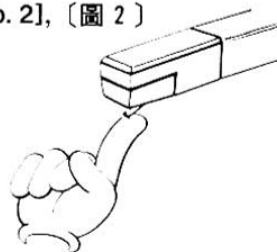

[Fig. 3], [Abb. 3], [圖 3]

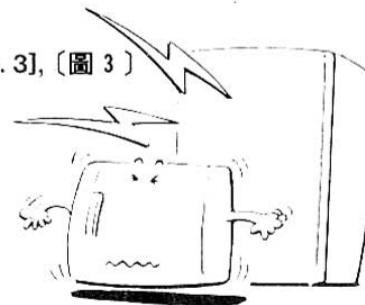





[Fig. 4], [Abb. 4], [圖 4]



NAMES OF PARTS AND THEIR FUNCTION

- 1. OPERATE Indicator**
Lights up when the tuner power switch is pushed "ON".
- 2. Repeat indicator**
This lights when the REPEAT button is "ON".
- 3. REPEAT button**
Set this to "ON" for repeat play. The repeat function is automatically released after the record has been played 10 times.
- 4. Up/down button ($\nabla \ \triangledown$)**
Use this to raise or lower the tone arm from the record surface.
- 5. Forward button (\blacktriangleleft)**
Pressing this button for manual operation raises the tonearm and moves it toward the next track. Releasing this button stops the tonearm during its upward movement. Press the Up/down button to start playing.
- 6. Reverse button (\blacktriangleright)**
Pressing this button for manual operation raises the tonearm and moves it toward the previous track. Releasing this button stops the tonearm during its upward movement. Press the Up/down button to start playing.
- 7. START/CUT button**
When this button is pushed, the tone arm automatically moves to the record and descends, and play starts.
When pushed during play, the tone arm rises and automatically returns to the arm rest, and the platter stops rotating.

- 8. Platter shaft**
- 9. Rotation speed selector button (SPEED)**
Select the appropriate rotation speed for the record to be played.
 33 r.p.m. record
 AUTO 33 r.p.m. when the DISC SIZE selector switch is positioned to 30 cm, and 45 r.p.m. when positioned to 17 cm.
 45 r.p.m. record
- 10. DISC SIZE selector switch**
Switch this selector button to the appropriate size for the record to be played.
 30 cm record
 17 cm record
* For records of other sizes, use manual play.
- 11. Cartridge**
- 12. Tone arm**

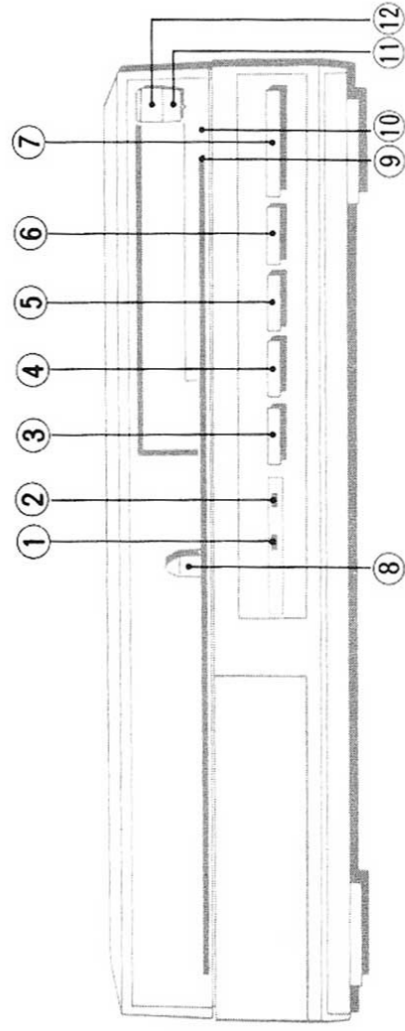

ASSEMBLY [Fig. 7]

1. Remove the transport holding screw

(A) Remove the red tonearm securing screw from the bottom panel.

(B) Remove the two screws used to secure the turntable. Lift the turntable and remove the two spacers used to protect the cabinet. Then, set the turntable in its original position.

(C) Remove the vinyl band and cardboard cover securing the tonearm.

- Keep the transport holding screw, vinyl band, cardboard cover and spacers in a safe place since they will be required when re-transporting the unit.

2. Attach the platter

Install the turntable, and loop the belt located inside the turntable around the motor spindle as shown in the figure.

Caution:

Install the turntable belt correctly, passing it around the motor pulley as shown in the figure. Don't pass it around the pulley's edge.

3. Attach the platter sheet

Place the platter sheet on the platter.

4. EP adaptor

Place the EP adaptor into the circular well at the front left of the chassis.

5. Dust cover attachment and removal

The dust cover can be attached and detached. To detach it, simply lift it up as shown in the figure.

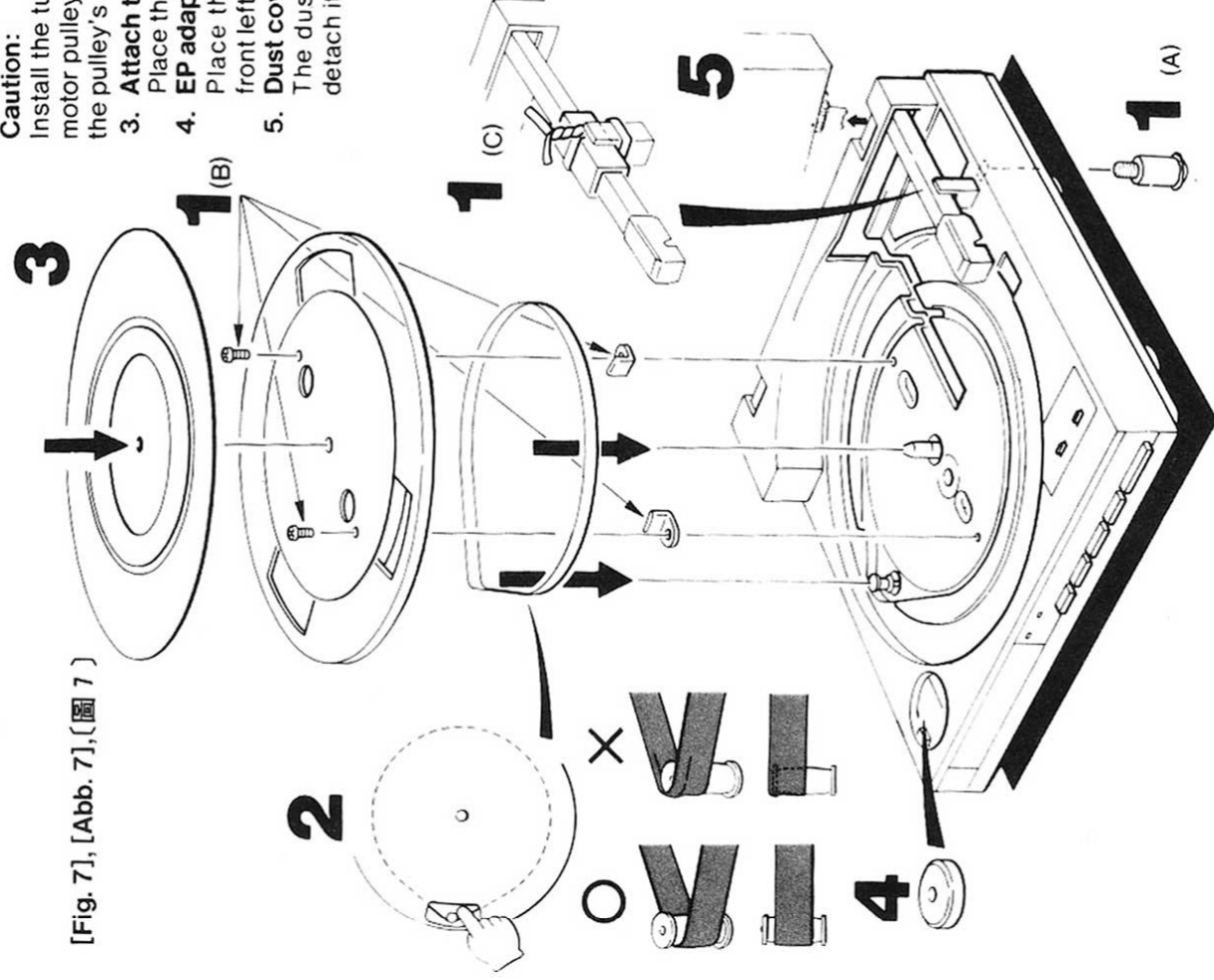

[Fig. 7], [Abb. 7], [圖 7]

AMPLIFIER CONNECTIONS [Fig. 8]

The output cord is plugged into the amplifier's PHONO jack, as shown in the figure.



ABOUT THE REMOTE CONTROL

When used with the Series 4000 system, the remote control transmitter included with the 4000 system can be used for remote control of the LX-330's start and stop functions.



OPERATION [Fig. 9]

Automatic play

1. Place the record on the platter.
2. Position the Rotation Speed selector button

(SPEED).
33 r.p.m. 
AUTO 
45 r.p.m. 

- When AUTO is selected, the rotation speed is automatically switched to 33 r.p.m. when the DISC SIZE selector button is positioned to 30 cm, and to 45 r.p.m. when the button is positioned to 17 cm.

3. Position the DISC SIZE selector button.
30 cm record 
17 cm record 
4. Push the START/CUT button.

- To stop play before the end of play

Push the up/down button. The tone arm rises and play will stop. If the up/down button is pushed again, the tone arm will descend and play will resume.

- To stop play

Press the START/CUT button. The tone arm rises and returns to the arm rest and the platter stops rotating.

- Once play finishes, the tone arm automatically returns to its starting position and the platter stops rotating.

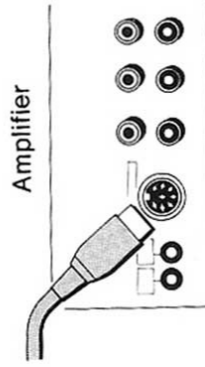

[Fig. 8], [Abb. 8], [圖 8]

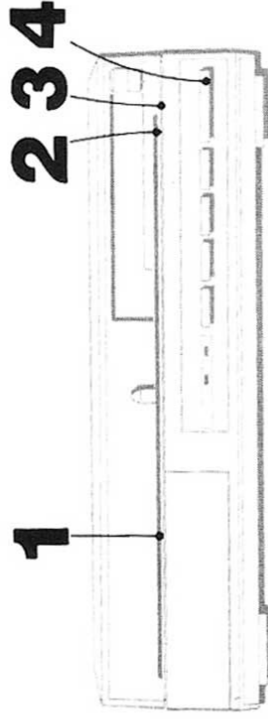

[Fig. 9], [Abb. 9], [圖 9]

Precautions during automatic operation

- During automatic operation, never stall the tonearm movement by hand, or force it while the tonearm is moving.
- This turntable uses the record start and end positions specified by the Japanese Industrial Standards (JIS). If you play a record which does not meet the JIS standards, during automatic operation the stylus may not land on the record at the correct starting position, alternatively, the end position may not be detected. If this happens, use manual operation.
- Do not stack records when playing since this may cause unreliable operation.

FORWARD/REVERSE button [Fig. 10]

Pressing the FORWARD button (◀) makes the tonearm move forwards. Pressing the REVERSE button (▶) makes the tonearm move backwards. Pressing these buttons while playing a record raises and moves the tonearm. Releasing the buttons allows you to stop the tonearm during its upward movement. Press the UP/DOWN button to lower the tonearm and start playing once more.

[Fig. 10], [Abb. 10], [圖10]

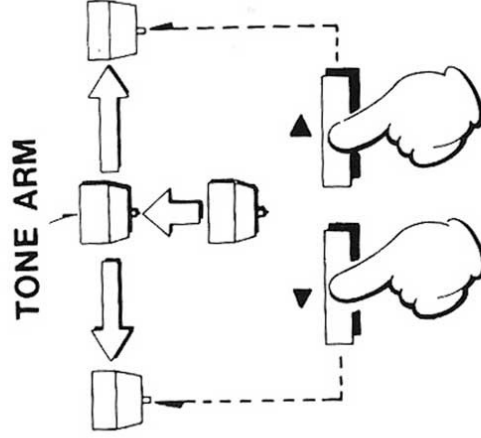

MANUAL PLAY [Fig. 11]

1. Place the record on the platter.
2. Position the Rotation Speed selector switch (SPEED).
 - 33 r.p.m.
 - AUTO
 - 45 r.p.m.
 - When AUTO is selected, the rotation speed is automatically switched to 33 r.p.m when the DISC SIZE selector switch is positioned to 30 cm, and to 45 r.p.m. when te button is positioned to 17 cm.
3. Position the DISC SIZE selector switch.
 - 30 cm record
 - 17 cm record
4. Push the "◀" FORWARD button and move the tone arm to the start of the track which is to be heard. (The platter will now start rotating.)
5. When the up/down button is pressed, the tone arm will now descend onto the record and play will start.
 - To stop play before the end of play
 - Push the up/down button. The tone arm rises and play will stop. If the up/down button is pushed again, the tone arm will descend and play will resume.
 - To stop play
 - Press the START/CUT button. The tone arm rises and returns to the arm rest and the platter stops rotating.
 - Once play finishes, the tone arm automatically returns to the arm rest and the platter stops rotating.
 - The end of a record whose size cannot be detected automatically will not be detected. It is therefore necessary to press the START/CUT button upon completion of play.

[Fig. 11], [Abb. 11], [圖11]

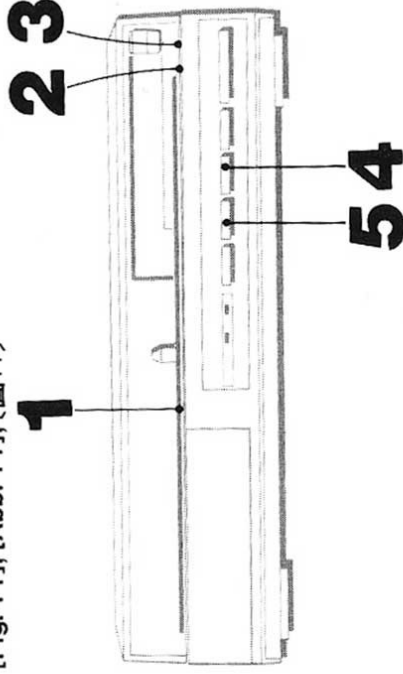

- **About the Synchronizing Mechanism**

When a record is recorded on the Series 4000 or Series 3000, recording automatically begins as the LX-330 tonearm lowers; recording automatically stops when play ends. For operating procedures please read the amplifier operation manual.

REPEAT OPERATION

Repeat operation is possible with this unit. Set the REPEAT button to ON when playing the record more than once. At this time the repeat indicator will light up to indicate that repeat operation is possible. In order to halt repeat operation, set the REPEAT button to OFF.

The tone arm will first go to the end of the record and then return.

- **When Terminating Play Immediately**

Press the START/CUT button. When this is done, the repeat function switches to "OFF" and the indicator lamp darkens.

STYLUS REPLACEMENT

This unit employs a diamond stylus with a usable life of approximately 500 hours. Using an old stylus will result in sound distortion or will damage the record. When replacing the stylus, slowly pull out the old stylus in the direction indicated with an arrow and insert a new stylus. [Fig. 12]

- An AIWA AN-77 stylus is recommended for replacement. This can be obtained from your AIWA dealer or service center.

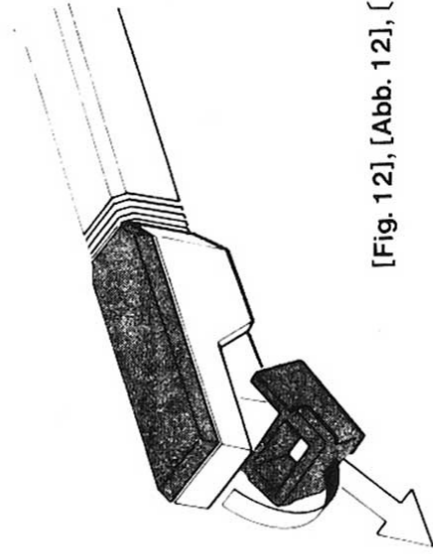

[Fig. 12], [Abb. 12], [圖12]

SPECIFICATIONS

< Turntable Section >

Drive system

Belt drive system

DC servo motor

Aluminum alloy diecast

33-1/3 and 45 rpm

0.055% (WRMS)

70 dB (DIN-B)

Turntable platter

Speeds

Wow & flutter

S/N ratio

< Tonearm Section >

Type

Linear tracking type,

straight dynamic

balanced type

< Cartridge >

Type

VM type

20—20,000 Hz

2.5 mV (1 kHz, 3.54 cm/sec)

Frequency response

Output voltage

< General >

Power requirements

DC 12 V, 0.2A

330(W) × 85(H) × 333(D)

mm

(13" × 3-3/8" × 13-1/8")

2.6 kg (5.7 lbs.)

EP adaptor

Weight

Accessories

- Specifications and design are subject to change without notice.